



MEDICAL

MADE IN GERMANY

CE / ISO 9001

2024
Product catalog



SINUSCOPY

Developed and manufactured in Germany



RG Medical USA, Inc. |



630 Pleasant Grove Rd, Mount Juliet, TN 37122



+54 9 11 5509-6530

www.rgmed.com

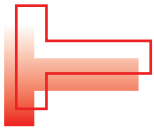
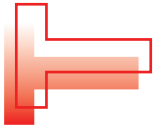

03

Scopes - compatibility

04

Autoclave

05

Handles

06

Septum elevators

07

Nasal cutting forceps

10 Circular forceps

11 Antrum punches

12 Sphenoid bone punches

14 Punches

2024+

Product catalog

www.rgmed.com

Scopes



In addition to our endoscopes, we produce endoscopes comparable to the following brands upon request

Compatibility

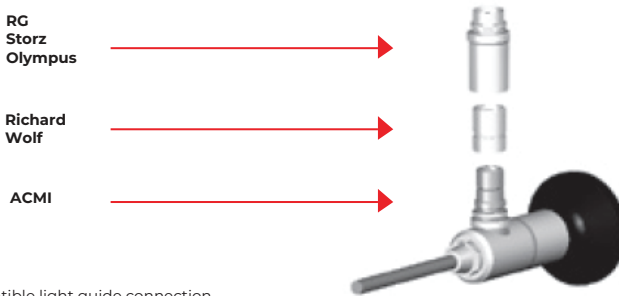

Compatible light guide connection

The advantages of RG endoscopes:

- The optical system is less sensitive to bending
- Higher flexibility compared to standard rigid endoscopes
- Higher robustness (70% off all repairing is due to broken rod-lenses caused by bent tubes)
- Scratch-proof saphirer glass on the distal end and ocular side
- High resolution and contrast reproduction
- 1 year waeenty against broken rod-lenses

Autoclave 134° C / 273° F

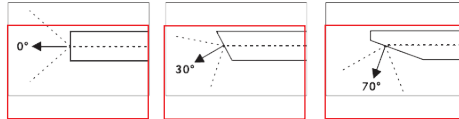

Sinuscope, Ø 2,7 mm, WL 105mm

Direction of view	Non-autoclavable	Autoclavable
0°	S60-001-00	S60-001-00A
30°	S60-001-30	S60-001-30A
70°	S60-001-70	S60-001-70A

Sinuscope, Ø 2,7 mm, WL 140mm

Direction of view	Non-autoclavable	Autoclavable
0°	S60-002-00	S60-002-00A
30°	S60-002-30	S60-002-30A
70°	S60-002-70	S60-002-70A

Sinuscope, Ø 2,7 mm, WL 185mm

Direction of view	Non-autoclavable	Autoclavable
0°	S60-003-00	S60-003-00A
30°	S60-003-30	S60-003-30A
70°	S60-003-70	S60-003-70A

Sinuscope, Ø 4 mm, WL 185mm

Direction of view	Non-autoclavable	Autoclavable
0°	S60-004-00	S60-004-00A
30°	S60-004-30	S60-004-30A
70°	S60-004-70	S60-004-70A

Autoclave 134° C / 273° F



Handles for sinuscopes



Mini Sinuscope, Ø 1,7 mm, WL 107mm

Direction of view	Non-autoclavable	Autoclavable
0°	S60-000-00	S60-000-00A

For scopes 0° - 70°

Ø	Length	Art. N°
Ø 2.7 mm	111 mm	S60-000-01
Ø 4.0 mm	110 mm	S60-000-02

Trocac

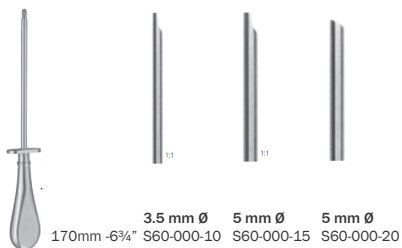

170mm - 6¾" S60-000-10 S60-000-15 S60-000-20

Eustachian catheters



160mm - 6" 2.5 mm Ø 3.0 mm Ø S60-100-16 S60-200-16

Universal Light Cable

Ø	Working length	
3.5 mm	1800mm	E1-035-18
3.5 mm	2300mm	E1-035-23
3.5 mm	3000mm	E1-035-30
4.8 mm	1800mm	E1-048-18
4.8 mm	2300mm	E1-048-23
4.8 mm	3000mm	E1-048-30

With silicone-rubber sheath, autoclavable, waterproof, very flexible, heat resistant from approx. -60° to approx. +180° Centigrade.



Septum elevators

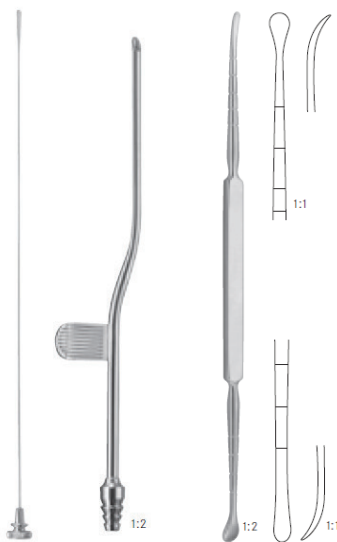

200mm - 8" S60-101-20

210mm - 8 1/4" S60-101-21

Light Cable - Light Source - Adapter

Storz		E1-1-S
Olympus		E1-1-0
Wolf / Dyonics		E1-1-WD
ACMI / British Standard		E1-1-AB
Pentax		E1-1-P
Fuji		E1-1-F

Light Cable - Endoscope - Adapter

Storz / Olympus		E1-2-S0
Wolf		E1-2-W
ACMI		E1-2-A

Septum elevators



Freer
205mm - 8"
S60-102-20



Masing
200mm - 8"
S60-102-21



Cottle
220mm - 8 3/4"
S60-102-22



195mm - 8 3/4"
S60-100-20

Nasal cutting forceps

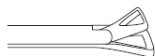

Schmeden
x= 120mm - 4 3/4"



S60-103-11



S60-103-12



S60-103-13



Tomati
x= 120mm - 4 3/4" S60-104-12



Struycken
x= 120mm - 4 3/4" S60-105-01

0.9 mm

1.2 mm

S60-105-02

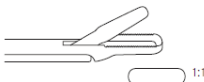

Henke
x= 120mm - 4 3/4" S60-106-01

Nasal scissors

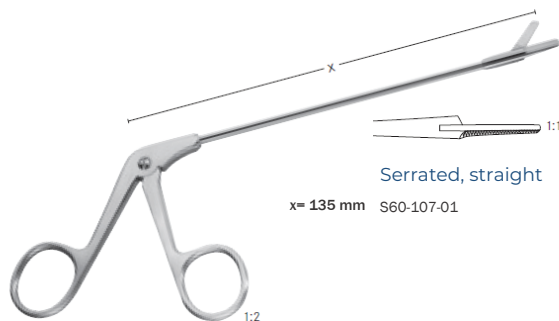

Serrated, straight

x= 135 mm S60-107-01



Serrated, right

S60-107-02



Serrated, left

S60-107-03

Nasal cutting forceps

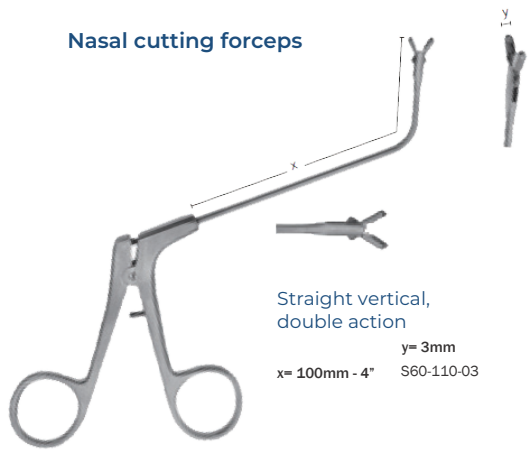

Straight vertical,
double action
y= 3mm
x= 100mm - 4" S60-110-03

Straight hor.,
double action
y= 3mm
x= 100mm - 4" S60-111-03

Straight hor.,
single action
y= 3mm
x= 100mm - 4" S60-112-03



45° vertical,
double action
y= 3mm
x= 100mm - 4" S60-113-03



45° hor.,
double action
y= 3mm
x= 100mm - 4" S60-114-03



45° hor.,
single action, short
y= 3mm
x= 100mm - 4" S60-115-03



70° vertical,
double action
y= 3mm
x= 100mm - 4" S60-116-03



70° hor.,
double action
y= 3mm
x= 100mm - 4" S60-117-03



110° hor.,
single action
y= 3mm
x= 100mm - 4" S60-118-03

70° vertical,
single action, short
y= 3mm
x= 100mm - 4" S60-119-03

70° hor.,
single action
y= 3mm
x= 100mm - 4" S60-120-03

Nasal cutting forceps



45° vertical,
double action

y= 4mm

x= 100mm - 4" S60-110-04



45° hor.,
double action, short

y= 4mm

x= 100mm - 4" S60-111-04

45° vertical,
single action, short

y= 4mm

x= 100mm - 4" S60-112-04



70° vertical,
double action

y= 4mm

x= 100mm - 4" S60-113-04



70° hor.,
double action, short

y= 4mm

x= 100mm - 4" S60-114-04

70° vertical,
single action, short

y= 4mm

x= 100mm - 4" S60-115-04

Circular forceps



Straight

Curved upwards

y= 180mm - 7"

y= 180mm - 7"

3.5mm Ø

S60-130-03

S60-131-03

4.5mm Ø

S60-130-04

S60-131-04

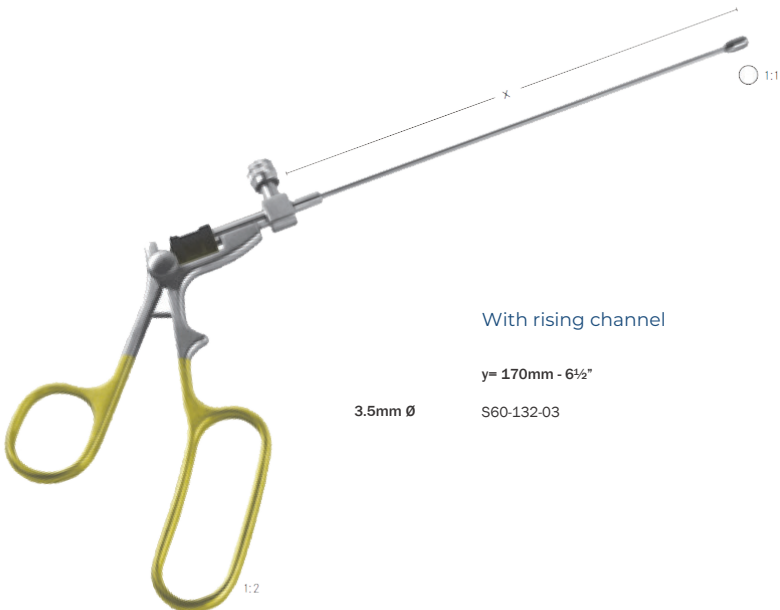

With rising channel

y= 170mm - 6½"

3.5mm Ø

S60-132-03

Antrum punches

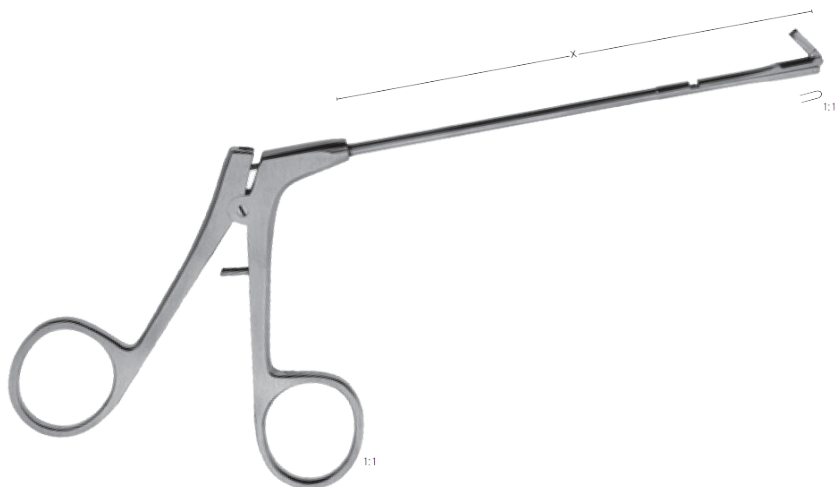

x= 100mm
1.5mm x 4.5mm

backward, up-cutting

S60-140-01

backward, cut to the right

S60-140-02

backward, cut to the left

S60-140-03

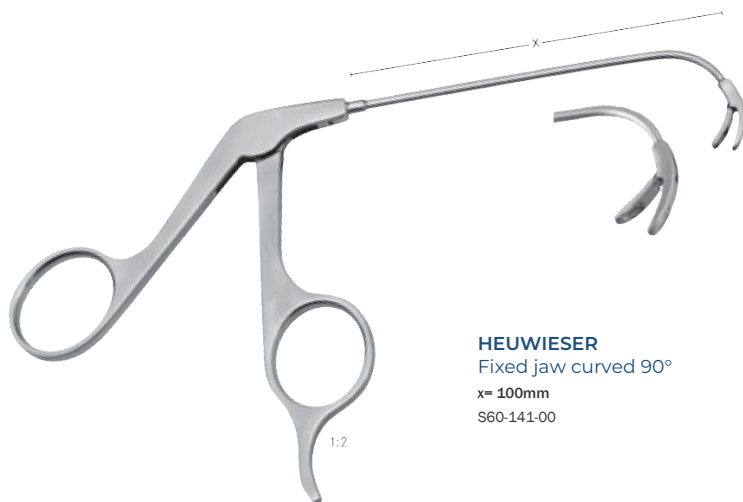

HEUWIESER
Fixed jaw curved 90°

x= 100mm
S60-141-00

Sphenoid bone punches



1:1

HAJEK UP

x= 140 mm - 5½"
4.0mm x 4.0mm

S60-150-00



1:1

HAJEK - KOFLER UP

x= 140 mm - 5½"
3.5mm x 3.5mm

S60-150-01



1:1

HAJEK DOWN

x= 140 mm - 5½"
4.0mm x 4.0mm

S60-151-00



1:1

HAJEK - KOFLER DOWN

x= 140 mm - 5½"
3.5mm x 3.5mm

S60-151-01

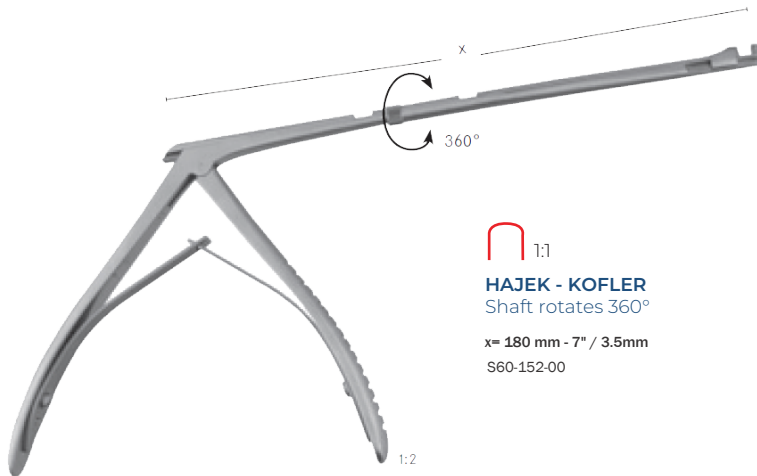

1:1

HAJEK - KOFLER
Shaft rotates 360°

x= 180 mm - 7" / 3.5mm
S60-152-00

Punched sphenoid bone



HAJEK - CLAUS

200mm - 8"
S60-160-00



CITELLI

170mm - 6¾"
x=60mm



2.2mm
S60-160-01



3.0mm
S60-160-02



KERRISON

x = 90mm - 3½"
200mm - 8"



4mm x 4mm
S60-170-00



5mm x 5mm
S60-170-01



6mm x 6mm
S60-170-02



FERRIS - SMITH - KERRISON

		x= 150mm - 6"	x= 180mm - 7"
	1mm	S60-170-01	S60-171-01
	2mm	S60-170-02	S60-171-02
	3mm	S60-170-03	S60-171-03
	1mm	S60-172-01	S60-173-01
	2mm	S60-172-02	S60-173-02
	3mm	S60-172-03	S60-173-03
	1mm	S60-174-01	S60-175-01
	2mm	S60-174-02	S60-175-02
	3mm	S60-174-03	S60-175-03

FERRIS - SMITH - KERRISON

Thin footplate

	x= 180mm - 7"	
	1mm	S60-176-01
	2mm	S60-176-02
	3mm	S60-176-03



 RG Medical USA, Inc. |  630 Pleasant Grove Rd, Mount Juliet, TN 37122

 +54 9 11 5509-6530

www.rgmed.com