

2026
Product catalogs



■ LAPAROSCOPY

Developed and manufactured in Germany.



- 
- 03** Full HD camera & Insufflator
 - 04** Instrument Holding Systems
 - 05** Laparoscopes and accessories
 - 06** Trocar - systems and accessories
 - 09** Suction and irrigation systems
 - 10** Modular suction / irrigation system
 - 11** Monopolar suction / irrigation HF Electrodes
 - 12** Monopolar suction / irrigation HF sliding electrodes
 - 13** Monopolar HF electrodes and cables
 - 14** Accesories
 - 17** Hemolock Model ML / L / XL & Bulldog

- 18** Modular bipolar coagulation forceps, 5mm
- 20** New: Powergrip bipolar coagulation forceps, 5mm
- 21** Modular instrument handles rotatable / detachable
- 22** Modular Shafts
- 23** Modular 5mm inserts - Grasping and dissecting
- 25** Modular 5 mm inserts - Biopsy and scissors
- 26** Modular 10mm inserts - Grasping and dissecting
- 27** Needle holders
- 29** EasyKnot and wound closure forceps
- 30** Led 10W portable



2026

Product catalog

MEDICAL MONITORS



Specifications

- ▷ Screen Size 23.8"
- ▷ Resolution 1920 x 1080
- ▷ Brightness 600cd/m²
- ▷ Color Depth 16.7M colors
- ▷ Viewing angle 78/178
- ▷ Response time (GtoG) 14ms

M-23.8CL1

COMBO

Full HD Camera + 300w. LED Lightsource. Records in full HD 1080p 60 frames



Specifications

- ▷ LED 300
- ▷ 1/3" 3.0 Megapixel CMOS Sensor
- ▷ Color: 0.1Lux@F1.2
- ▷ 1920x1080 / 60Hz Full HD
- ▷ 3G SDI 1080p
- ▷ HDMI 1080p
- ▷ C-Video composite video
- ▷ 5300 K

E-CHD1

* The set has: Equipment camera led combo, Wireless 1080p Camera and 2.5 lighth cable.

HIGH FLOW 40-LITER INSUFFLATOR



**2 Years
Warranty**

Specifications

- ▷ Digital Insufflator 40 litros
- ▷ The highest flow rate available on the market
- ▷ Optional gas heating technology
- ▷ Surgivent-electronic venting system for added safety
- ▷ Visual and audible warning signals
- ▷ Safety Relief Valve
- ▷ Internal Leakage Detection

E-IN40

AUTOCLAVE
134° C / 273° F

HD



Laparoscope, Ø 5 mm, WL 300 mm

Direction of view

0°	E050-300-00
30°	E050-300-30
45°	E050-300-45

Laparoscope, Ø 6.5 mm, WL 300 mm

Direction of view

0°	E065-300-00
30°	E065-300-30

Laparoscope, Ø 10 mm, WL 300 mm

Direction of view

0°	E100-310-00
30°	E100-310-30
45°	E100-310-45

Bariatric Laparoscope, Ø 10 mm, WL 400 mm

Direction of view

0°	E100-400-00
30°	E100-400-30
45°	E100-400-45

Endoscope - Adapter

Storz/ Olympus



L1-005-01

Wolf



L1-005-02

Operating Laparoscope



Working Ø

Length	10,0 mm
Instrumental	280 mm
Channel	6 mm
Direction of view	0°

L1-006-01

**Stop cock for Ø10 mm Operating Laparoscope
incl. 1 stop cock and sealing cap**

L1-006-02



Sealing cap for stop cock

L1-006-03

Ring applicator



Working Ø 6 mm, WL 330 mm	L1-007-01
Working Ø 7 mm, WL 290 mm	L1-007-02
Insert cones for (L1-007-01/L1-007-02)	L1-007-03
Applier for (L1-007-01/L1-007-02)	L1-007-04

Silicon Rings, 50 pcs./pack

L1-007-05

Universal Light Cable

Ø	Working length	
3.5 mm	1800 mm	E1-035-18
3.5 mm	2300 mm	E1-035-23
3.5 mm	3000 mm	E1-035-30
4.8 mm	1800 mm	E1-048-18
4.8 mm	2300 mm	E1-048-23
4.8 mm	3000 mm	E1-048-30

With silicone-rubber sheath, autoclavable, waterproof, very flexible, heat resistant from approx. -60° to +180° Centigrade.



Light Cable - Light Source - Adapter

Storz		E1-1-S
Olympus		E1-1-O
Wolf / Dyonics		E1-1-WD
ACMI / British Standard		E1-1-AB
Pentax		E1-1-P
Fuji		E1-1-F

Light Cable - Endoscope - Adapter

Storz / Olympus		E1-2-SO
Wolf		E1-2-W
ACMI		E1-2-A

Instrument Holding Systems



For 10 mm scopes or instruments, 420 mm Working Radius **E2-001-01**

For 3-10 mm scopes or instruments, 420 mm Working Radius **E2-001-02**

Instrument L-Holder



Instrument L-Holder for 10 mm scopes or instruments, 480 mm working radius **E2-001-03**

Instrument L-Holder for 3-10 mm scopes or instruments, 480 mm working radius **E2-001-04**

Liver retractor



Live retractor for universal holder, medium **E02-002-01**

Live retractor for universal holder, large **E02-002-02**

Universal retractor holder **E2-002-03**



Endoscope holder Ø 8 / 10 mm **E2-002-04**



Universal Endoscope holder Ø 2,7 - 10 mm **E2-002-05**



Joint extension 180mm long-lockable **E2-002-06**



Double tube holder made of aluminium **E2-002-07**



Universal tube holding plate **E2-002-08**



Trumpet Valve Cannula

<u>Inside-Ø</u>	<u>with metal smooth sleeve</u>	<u>with metal threaded sleeve</u>
5.5 mm	L2-010-05	L2-011-05
11.0 mm	L2-010-11	L2-011-11
12.5 mm	L2-010-12	L2-011-12

Automatic Valve Cannula

<u>Inside-Ø</u>	<u>with metal smooth sleeve</u>	<u>with metal threaded sleeve</u>
3.5 mm	L2-020-03	L2-021-03
5.5 mm	L2-020-05	L2-021-05
7.5 mm	L2-020-07	L2-021-07
11.0 mm	L2-020-11	L2-021-11
12.5 mm	L2-020-12	L2-021-12

Automatic Cannula with manual lever

<u>Inside-Ø</u>	<u>with metal smooth sleeve</u>	<u>with metal threaded sleeve</u>
5.5 mm	L2-030-05	L2-031-05
7.5 mm	L2-030-07	L2-031-07
11.0 mm	L2-030-11	L2-031-11
12.5 mm	L2-030-12	L2-031-12

LITE-LINE Cannula with silicone seal w/o stopcock

<u>Inside-Ø</u>	<u>with metal smooth sleeve</u>	<u>with metal threaded sleeve</u>
5.5 mm	L2-040-05	L2-041-05

LITE-LINE
Cannula with silicone seal with stopcock

<u>Inside-Ø</u>	<u>with metal smooth sleeve</u>	<u>with metal threaded sleeve</u>
5.5 mm	L2-050-05	L2-051-05
1.0 mm	L2-050-11	L2-051-11
12.5 mm	L2-050-12	L2-051-12

LITE-LINE
Silicone seals

5.5 mm	L2-052-05
11.0/12.5 mm	L2-052-11

Hasson Cannula Set

<u>Inside-Ø</u>	<u>with Trumpet Valve</u>	<u>with atraumatic valve</u>	<u>with manual lever and auto. valve</u>
5.5 mm	L2-060-05	L2-061-05	L2-062-05
11.0 mm	L2-060-11	L2-061-11	L2-062-11
12.5 mm	L2-060-12	L2-061-12	L2-062-12

Accessories for Hasson Cannula

Hasson Cone
L2-063-01



Fascia Holder
L2-064-01

Obturator

<u>Outside-Ø</u>	<u>Hasson Cone</u>	<u>Obturator</u>	<u>Fascia Holder</u>
5.5 mm	L2-070-05	L2-071-05	L2-072-05
11.0 mm	L2-070-11	L2-071-11	L2-072-11
12.5 mm	L2-070-12	L2-031-12	L2-032-12

Accessories for Cannula, WL 100 mm, custom lengths available upon request



Inside-Ø

5.5 mm
7.5 mm
11.0 mm
12.5 mm

Metal smooth sleeve

L2-080-05
L2-080-07
L2-080-11
L2-080-12

Plastic Smooth sleeve

L2-081-05
L2-081-07
L2-081-11
L2-081-12

Metal threaded sleeve

L2-082-05
L2-082-07
L2-082-11
L2-082-12

Plastic threaded sleeve

L2-083-05
L2-083-07
L2-083-11
L2-083-12

Sealing caps



Inside-Ø

5.5 mm
7.5 mm
11.0 mm
12.5 mm

Sealing caps 10/pack

L2-090-05
L2-090-07
L2-090-11
L2-090-12

O-Rings 10/pack

L2-091-05
L2-091-07
L2-091-11
L2-091-12

Veress shielded trocar



Outside-Ø

3.5 mm
5.5 mm
11.0 mm
12.5 mm

L2-100-03
L2-100-05
L2-100-11
L2-100-12

Trocar, pyramidal point



Inside-Ø

5.5 mm
7.5 mm
11.0 mm
12.5 mm

L2-110-05
L2-110-07
L2-110-11
L2-110-12

Trocar, conical point



Inside-Ø

5.5 mm
7.5 mm
11.0 mm
12.5 mm

L2-120-05
L2-120-07
L2-120-11
L2-120-12

Shielded Trocar with automatic tip cover and lock



Outside-Ø

5.5mm
10.5mm Storz
11.0mm
12.5mm

L2-130-05
L2-130-10
L2-130-11
L2-130-12

Shielded Blade Trocar with automatic tip cover



Outside-Ø

5.5mm
10.5mm Storz
11.0mm
12.5mm

with lock

L2-140-05
L2-140-10
L2-140-11
L2-140-12

without lock

L2-141-05
L2-141-10
L2-141-11
L2-141-12

Reducer-sleeve



Outside-Ø	Inside-Ø	
10 mm	5 mm	L2-150-10
11 mm	5 mm	L2-150-11
12.5 mm	5 mm	L2-150-12
12.5 mm	10 mm	L2-150-13
15 mm	5 mm	L2-150-15
15 mm	10 mm	L2-150-16
20 mm	15 mm	L2-150-20
20 mm	10 mm	L2-150-21

Dilation Set with guide probe

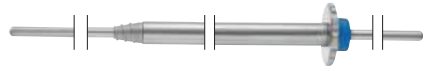

Inside-Ø	Inside-Ø	
5 mm	10 mm	L2-150-10
5 mm	11 mm	L2-150-11
10 mm	15 mm	L2-150-15
10 mm	20 mm	L2-150-20

Reducer-adapter



Outside-Ø	Inside-Ø	
11 mm	5 mm	L2-170-11
12.5 mm	5 mm	L2-170-12

Reducer-short



Outside-Ø	Inside-Ø	
11 mm	5 mm	L2-171-11
12.5 mm	5 mm	L2-171-12

S-retractor, set of 2



5.5 mm	L2-172-11
11 mm	L2-172-12

Veress Insufflation-cannula



Working length	Ø 2.0 mm
80 mm	L2-180-08
100 mm	L2-180-10
120 mm	L2-180-12
150 mm	L2-180-15
170 mm	L2-180-17
200 mm	L2-180-20



Luer Lock End Cap
L2-190-01



Female Luer Lock Tubing Adapter
L2-190-02



Male Luer Lock Tubing Adapter
L2-190-03

Adaptable Suction-/Irrigation Tubes for L3-002-01 / L3-002-02 / L3-002-03



Outside-Ø	Inside-Ø	
3 mm	330 mm	L3-003-03
5 mm	330 mm	L3-003-05
10 mm	330 mm	L3-003-10



Single Trumpet Valve Handle

L3-001-01



Double Trumpet Valve Handle with detachable ergonomic handle plate

L3-001-02



Pistol handle with maintenance-free 2-way valve

L3-001-03

Adaptable Suction/Irrigation Tube for L3-004-01



Outside-Ø	Working Length	
3 mm	330 mm	L3-004-03
5 mm	330 mm	L3-004-05
10 mm	330 mm	L3-004-10

Adaptable Injection/Puncture Needle for L3-004-01



Outside-Ø	Working Length	
5 mm	330 mm	L3-004-50

Maintenance-free 2-Way Valve with rotating adapter and LL-connector

L3-004-01



Injection/Puncture Needle, small LL-connector for syringes



Outside-Ø	Working Length	
3 mm	330 mm	L3-005-03
5 mm	330 mm	L3-005-05
10 mm	450 mm	L3-006-10

Irrigation Channel Insert for L3-007-01



L3-007-02

Suction and Irrigation Tubw with two lateral trumpet valves Ø 5 mm, WL 330 mm



L3-007-01

Laser Channel Insert for L3-007-01



L3-007-03

Endo Suction/Irrigation tubes



Endo Suction/Irrigation tubes, WL 330 mm,for L3-010-01

- Ø 5 mm L3-010-05
- Ø 10 mm L3-010-10



Endo-Suction-Irrigation handle
L3-010-01

Suction Tube with one lateral trumpet valve, 5mm, WL 330mm



Stop Cock Valve Handle
L4-001-01



Single Trumpet Valve Handle
L4-001-02



Two way valve Handle
L4-001-03



Double trumpet valve handle with detachable ergonomic handle plate
L4-001-04



Pistol Handle with maintenance free 2-way valve
L4-001-05

Adaptable monopolar HF-Electrodes for modular handles of series L4-001-01 /L4-001-02/
L4-001-03/L4-001-04 and L4-001-05



Adaptable monopolar HF-Electrodes for modular handles of series L4-002-01 /L4-002-02/
L4-002-03/L4-002-04 and L4-002-05 with sliding insulation











1. Step



2. Step

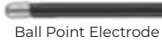

3. Step

Ø 5 mm	Adaptable electrodes		Adaptable electrodes with sliding insulation	
	Working Length		Working Length	
	340 mm 450 mm	L4-010-33 L4-010-45	340 mm 450 mm	L4-020-33 L4-020-45
	340 mm 450 mm	L4-011-33 L4-011-45	340 mm 450 mm	L4-021-33 L4-021-45
	340 mm 450 mm	L4-012-33 L4-012-45	340 mm 450 mm	L4-022-33 L4-022-45
	340 mm 450 mm	L4-013-33 L4-013-45	340 mm 450 mm	L4-023-33 L4-023-45
	340 mm 450 mm	L4-014-33 L4-014-45	340 mm 450 mm	L4-024-33 L4-024-45
	340 mm 450 mm	L4-015-33 L4-015-45	340 mm 450 mm	L4-025-33 L4-025-45
	340 mm 450 mm	L4-016-33 L4-016-45	340 mm 450 mm	L4-026-33 L4-026-45
	340 mm 450 mm	L4-017-33 L4-017-45	340 mm 450 mm	L4-027-33 L4-027-45
	340 mm 450 mm	L4-018-33 L4-018-45		

Monopolar electrodes with HF-Connector



Electrodes with HF-Connector

Ø 5 mm Working Length

 340 mm L4-030-33
450 mm L4-030-45

 340 mm L4-031-33
450 mm L4-031-45

 340 mm L4-032-33
450 mm L4-032-45

 340 mm L4-033-33
450 mm L4-033-45

 340 mm L4-034-33
450 mm L4-034-45

 340 mm L4-035-33
450 mm L4-035-45

 340 mm L4-036-33
450 mm L4-036-45

 340 mm L4-037-33
450 mm L4-037-45

Generator side

US-American ESU's



with standard instrument connector

Length 300 mm L4-100-00

Martin, Berchtold, Erbe T-Series



with standard instrument connector

Length 300mm L4-100-01



“Wound closure” Forceps, WL 170 mm

- 200 mm L5-001-020
- 270 mm L5-001-027
- 300 mm L5-001-030



Endo-Ligature Applicator
L5-001-02

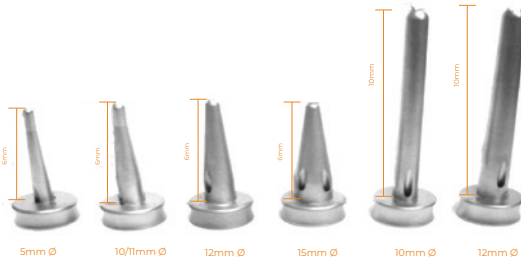

Trocar suture guide

Working length

- 5 mm L5-001-105
- 10/11 mm L5-001-110
- 15mm L5-001-115
- 10cm long 10 mm L5-001-210
- 10cm long 12 mm L5-001-212

Knot pusher, Ø 5 mm



with suture opening

Working length

- 330 mm L5-021-33
- 450 mm L5-021-45



without suture opening

Working length

- 330 mm L5-022-33
- 450 mm L5-022-45



Palpation Probe Ø 5 mm, graduated

Working length

- 330 mm L5-024-33
- 450 mm L5-024-45



Myoma Screw Ø 5 mm

Working length

- 330 mm L5-025-33
- 450 mm L5-025-45

Myoma Screw Ø 10 mm

Working length

- 330 mm L5-027-33
- 450 mm L5-027-45

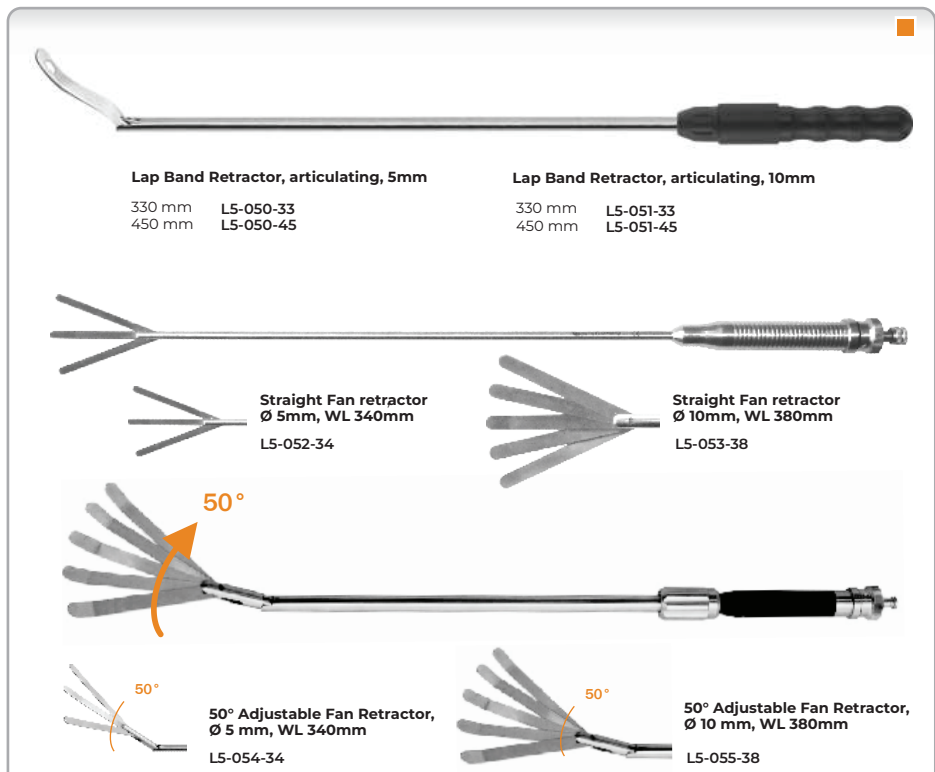
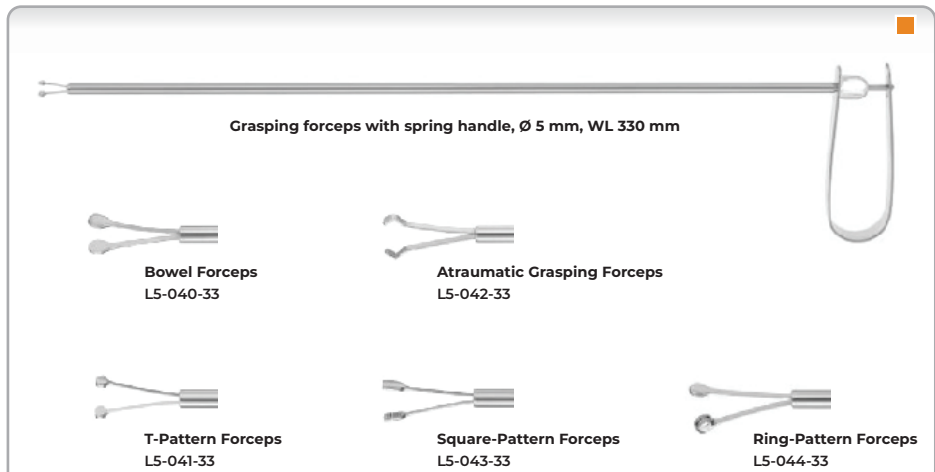



Speculum with 3 blades for extraction of gall bladder, WL 55mm

L5-060-55



Cholangiography Probe, radiolucent, WL 330mm

Ø 11.0 mm L5-061-11
Ø 12.5 mm L05-061-12



Aggressive 3 Prong grasper 5mm, WL 330mm

L05-070-01

Allis 3 Prong grasper, 5mm, WL 330mm

L5-070-02



Titanium Rotatable Clip Applier, WL 330mm

- | | | |
|--|----------------------|-----------|
| | LT400 for 10 x 330mm | L5-074-33 |
| | LT300 for 10 x 330mm | L5-073-33 |
| | LT200 for 5 x 330mm | L5-072-33 |
| | LT100 for 5 x 330mm | L5-071-33 |

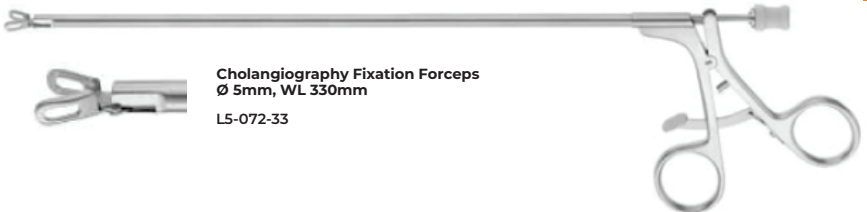

Cholangiography Fixation Forceps Ø 5mm, WL 330mm

L5-072-33

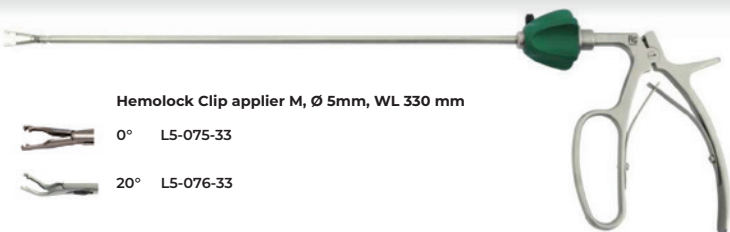

Hemolock Clip applicator M, Ø 5mm, WL 330 mm

0° L5-075-33

20° L5-076-33



Hemolock Clip applicator L, Ø 10mm, WL 330 mm

0° L5-077-33

20° L5-078-33



Hemolock Clip applicator XL, Ø 10mm, WL 330 mm



0° L5-079-33

20° L5-080-33



Bulldog - Clip applicator L, Ø 10mm, WL 330 mm

Length
10 x 330 mm L5-080-33

Clip applicator			
			
Length	Thin	Thick	Curved
450 mm	L5-084-33	L5-086-33	L5-088-33
650 mm	L5-085-33	L5-087-33	L5-089-33

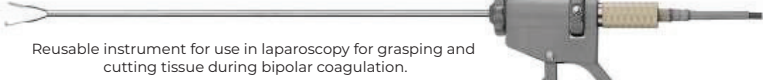

Reusable instrument for use in laparoscopy for grasping and cutting tissue during bipolar coagulation.



360°

Ring handle
L5-300-05

Comfortable Handling

The electrode can be rotated 360° for accurate jaw orientation. There is no receding of the jaw when closing. This allows precise grasping and coagulation of the tissue

Hygiene and cost effectiveness

The forceps are easily detachable. This allows to reliably clean even highly inaccessible areas. Because of its modular design, all parts are interchangeable and therefore easy to repair. The various electrodes can be all used in the same, ergonomically designed handle



Standard handle
L5-300-10



Outer tube
Working Length

- 200 mm L5-305-20
- 340 mm L5-305-34
- 450 mm L5-305-45

Inner tube
Working Length

- 200 mm L5-306-20
- 340 mm L5-306-34
- 450 mm L5-306-45



Adapter with flat plug
L5-310-01

Compatibility

The forceps in conjunction with the respective connection cable is compatible with the bipolar output of most electro-surgical generators not exceeding 60 Watts. An adapter can be used in order to connect a standard bipolar forceps cable.

Bipolar Silicon cables with rotatable plug



AUTOClave
134° C / 273° F



2 Banana Plugs
Length Rotatable plug
300 mm L5-403-01



Valleylab
Length Rotatable plug
300 mm L5-403-05



Wolf / Martin / Berchtold / Aesculap
Length Rotatable plug
300mm L5-403-10



Erbe / Select / Storz
Length Rotatable plug
300mm L5-403-15

NEW



Bipolar Scissor



Bipolar Maryland

Complete instrument

Bipolar forceps with rippled bar

With ring handle

200mm	L5-100-20
250mm	L5-100-25
340mm	L5-100-34
450mm	L5-100-45

Fine bipolar forceps, 1mm jaw

With ring handle

200mm	L5-102-20
250mm	L5-102-25
340mm	L5-102-34
450mm	L5-102-45

Bipolar forceps, 3 mm jaw

With ring handle

200mm	L5-104-20
250mm	L5-104-25
340mm	L5-104-34
450mm	L5-104-45

Bipolar grasping forceps, serrated jaw

With ring handle

200mm	L5-106-20
250mm	L5-106-25
340mm	L5-106-34
450mm	L5-106-45

Bipolar scissors, Curved

With ring handle

200mm	L5-108-20
250mm	L5-108-25
340mm	L5-108-34
450mm	L5-108-45

Bipolar Maryland, Curved

With ring handle

200mm	L5-110-20
250mm	L5-110-25
340mm	L5-110-34
450mm	L5-110-45

Insert only

Insert with rippled bar

Working length

200mm	L5-200-20
250mm	L5-200-25
340mm	L5-200-34
450mm	L5-200-45

Insert with 1 mm jaw

Working length

200mm	L5-202-20
250mm	L5-202-25
340mm	L5-202-34
450mm	L5-202-45

Insert with 3 mm jaw

Working length

200mm	L5-204-20
250mm	L5-204-25
340mm	L5-204-34
450mm	L5-204-45

Insert with serrated jaw

Working length

200mm	L5-206-20
250mm	L5-206-25
340mm	L5-206-34
450mm	L5-206-45

Scissors Insert

Working length

200mm	L5-208-20
250mm	L5-208-25
340mm	L5-208-34
450mm	L5-208-45

Maryland Insert

Working length

200mm	L5-210-20
250mm	L5-210-25
340mm	L5-210-34
450mm	L5-210-45

NEW



Reusable instrument for use in laparoscopy for grasping and cutting tissue during bipolar coagulation.



Ring handle
L5-500-05



Hygiene and Cost Effectiveness

The forceps are easily detachable. This allows to reliably clean even highly inaccessible areas. Because of it's modular design, all parts are interchangeable and therefore easy to repair. The various electrodes can be all used in the same, ergonomically designed handle.

Outer tube

Working length

200mm	L5-500-20
250mm	L5-500-25
340mm	L5-500-34
450mm	L5-500-45

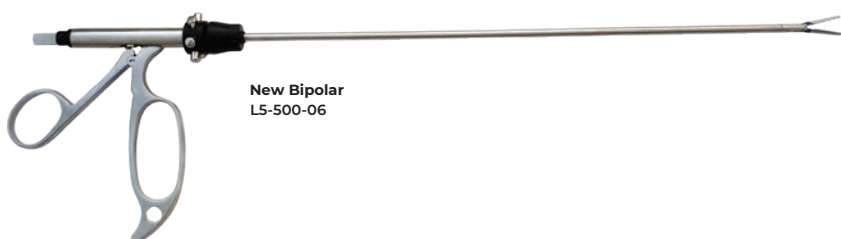

New Bipolar
L5-500-06

Bipolar grasper micro france fenestrated

	<u>Insert only</u>	<u>Complete instrument</u>
 200mm	L5-501-20	L5-601-20
 250mm	L5-501-25	L5-601-25
 340mm	L5-501-34	L5-601-34
 450mm	L5-501-45	L5-601-45

Bipolar grasping forceps fenestrated

	<u>Insert only</u>	<u>Complete instrument</u>
 200mm	L5-504-20	L5-604-20
 250mm	L5-504-25	L5-604-25
 340mm	L5-504-34	L5-604-34
 450mm	L5-504-45	L5-604-45

Bipolar grasping forceps delicate curved

	<u>Insert only</u>	<u>Complete instrument</u>
 200mm	L5-502-20	L5-602-20
 250mm	L5-502-25	L5-602-25
 340mm	L5-502-34	L5-602-34
 450mm	L5-502-45	L5-602-45

Bipolar scissors curved

	<u>Insert only</u>	<u>Complete instrument</u>
 200mm	L5-505-20	L5-605-20
 250mm	L5-505-25	L5-605-25
 340mm	L5-505-34	L5-605-34
 450mm	L5-505-45	L5-605-45

Bipolar grasping forceps curved fenestrated

	<u>Insert only</u>	<u>Complete instrument</u>
 200mm	L5-503-20	L5-603-20
 250mm	L5-503-25	L5-603-25
 340mm	L5-503-34	L5-603-34
 450mm	L5-503-45	L5-603-45

Bipolar Dissector Maryland curved

	<u>Insert only</u>	<u>Complete instrument</u>
 200mm	L5-506-20	L5-606-20
 250mm	L5-506-25	L5-606-25
 340mm	L5-506-34	L5-606-34
 450mm	L5-506-45	L5-606-45



Metal Shaft with shaft knob

Size	working length 220 mm	working length 330 mm	working length 450 mm
Ø 5 mm	L6-100-22	L6-100-33	L6-100-45
Ø 10-5 mm	L6-101-22	L6-101-33	L6-101-45
Ø 10 mm	L6-102-22	L6-102-33	L6-102-45



Metal Shaft, with cleaning port and shaft knob

Size	working length 220 mm	working length 330 mm	working length 450 mm
Ø 5 mm	L6-103-22	L6-103-33	L6-103-45
Ø 10-5 mm	L6-104-22	L6-104-33	L6-104-45
Ø 10 mm	L6-105-22	L6-105-33	L6-105-45

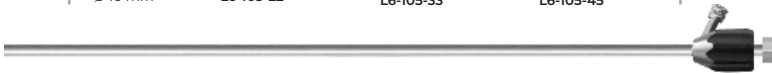

Insulated Shaft with shaft knob

Size	working length 220 mm	working length 330 mm	working length 450 mm
Ø 5 mm	L6-106-22	L6-106-33	L6-106-45
Ø 10-5 mm	L6-107-22	L6-107-33	L6-107-45
Ø 10 mm	L6-108-22	L6-108-33	L6-108-45



Insulated Shaft with cleaning port and shaft knob

Size	working length 220 mm	working length 330 mm	working length 450 mm
Ø 5 mm	L6-109-22	L6-109-33	L6-109-45
Ø 10-5 mm	L6-110-22	L6-110-33	L6-110-45
Ø 10 mm	L6-111-22	L6-111-33	L6-111-45



Shaft knob

Ø 5 mm	L6-112-05
Ø 10 mm	L6-113-10

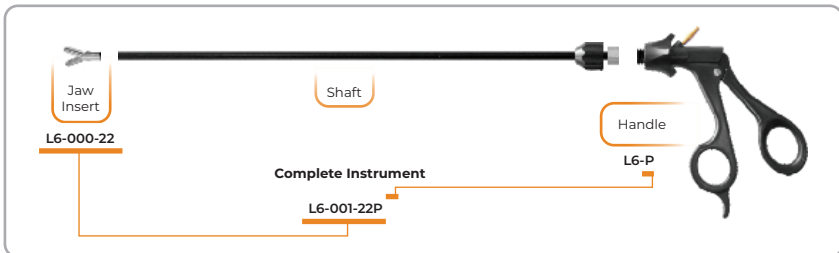



Cone Grasping insert

<u>working length</u>	<u>Jaw insert</u>
220 mm	L6-000-22
330 mm	L6-000-33
450 mm	L6-000-45



Wide Fenestrated insert

<u>working length</u>	<u>Jaw insert</u>
220 mm	L6-019-22
330 mm	L6-019-33
450 mm	L6-019-45



Long Dolphin insert

<u>working length</u>	<u>Jaw insert</u>
220 mm	L6-002-22
330 mm	L6-002-33
450 mm	L6-002-45



Micro fenestrated insert

<u>working length</u>	<u>Jaw insert</u>
220 mm	L6-020-22
330 mm	L6-020-33
450 mm	L6-020-45



Short Dolphin insert

<u>working length</u>	<u>Jaw insert</u>
220 mm	L6-004-22
330 mm	L6-004-33
450 mm	L6-004-45



Micro insert

<u>working length</u>	<u>Jaw insert</u>
220 mm	L6-022-22
330 mm	L6-022-33
450 mm	L6-022-45



Long Grasping with spoon

<u>working length</u>	<u>Jaw insert</u>
220 mm	L6-006-22
330 mm	L6-006-33
450 mm	L6-006-45



Micro Kelly insert

<u>working length</u>	<u>Jaw insert</u>
220 mm	L6-024-22
330 mm	L6-024-33
450 mm	L6-024-45



Grasping insert

<u>working length</u>	<u>Jaw insert</u>
220 mm	L6-008-22
330 mm	L6-008-33
450 mm	L6-008-45



Long atraumatic grasping up

<u>working length</u>	<u>Jaw insert</u>
220 mm	L6-026-22
330 mm	L6-026-33
450 mm	L6-026-45



Maryland insert

<u>working length</u>	<u>Jaw insert</u>
220 mm	L6-010-22
330 mm	L6-010-33
450 mm	L6-010-45



Grasping insert, straight

<u>working length</u>	<u>Jaw insert</u>
220 mm	L6-028-22
330 mm	L6-028-33
450 mm	L6-028-45



Kelly insert

<u>working length</u>	<u>Jaw insert</u>
220 mm	L6-012-22
330 mm	L6-012-33
450 mm	L6-012-45



Grasping insert, curved

<u>working length</u>	<u>Jaw insert</u>
220 mm	L6-030-22
330 mm	L6-030-33
450 mm	L6-030-45



Long atraumatic grasping

<u>working length</u>	<u>Jaw insert</u>
220 mm	L6-014-22
330 mm	L6-014-33
450 mm	L6-014-45



Alligator Grasping insert

<u>working length</u>	<u>Jaw insert</u>
220 mm	L6-032-22
330 mm	L6-032-33
450 mm	L6-032-45



Long atraumatic concave

<u>working length</u>	<u>Jaw insert</u>
220 mm	L6-016-22
330 mm	L6-016-33
450 mm	L6-016-45



Mixer 60° insert

<u>working length</u>	<u>Jaw insert</u>
220 mm	L6-034-22
330 mm	L6-034-33
450 mm	L6-034-45



Mixer 90° insert
working length Jaw insert
 220 mm L6-036-22
 330 mm L6-036-33
 450 mm L6-036-45



Alligator, with spoon
working length Jaw insert
 220 mm L6-038-22
 330 mm L6-038-33
 450 mm L6-038-45



DaVinci insert
working length Jaw insert
 220 mm L6-040-22
 330 mm L6-040-33
 450 mm L6-040-45



Maxi insert
working length Jaw insert
 220 mm L6-042-22
 330 mm L6-042-33
 450 mm L6-042-45



Mc Kearnan insert
working length Jaw insert
 220 mm L6-043-22
 330 mm L6-043-33
 450 mm L6-043-45



Crocodile, insert single action
working length Jaw insert
 220 mm L6-044-22
 330 mm L6-044-33
 450 mm L6-044-45



Crocodile, insert double action
working length Jaw insert
 220 mm L6-045-22
 330 mm L6-045-33
 450 mm L6-045-45



Retraction insert
working length Jaw insert
 220 mm L6-046-22
 330 mm L6-046-33
 450 mm L6-046-45



Oviduct insert
working length Jaw insert
 220 mm L6-048-22
 330 mm L6-048-33
 450 mm L6-048-45



Dissecting, fine pattern
working length Jaw insert
 220 mm L6-050-22
 330 mm L6-050-33
 450 mm L6-050-45



Endo-Klinch - Insert, 5mm
working length Jaw insert
 220 mm L6-054-22
 330 mm L6-054-33
 450 mm L6-054-45



Johan 17mm Fenestrated Diss. and Grasp
working length Jaw insert
 220 mm L6-056-22
 330 mm L6-056-33
 450 mm L6-056-45



Johan 25mm Fenestrated Diss. and Grasp
working length Jaw insert
 220 mm L6-057-22
 330 mm L6-057-33
 450 mm L6-057-45



Johan 40mm Fenestrated Diss. and Grasp
working length Jaw insert
 220 mm L6-058-22
 330 mm L6-058-33
 450 mm L6-058-45



Fenestrated Bowel insert
working length Jaw insert
 220 mm L6-059-22
 330 mm L6-059-33
 450 mm L6-059-45



Allis insert
working length Jaw insert
 220 mm L6-062-22
 330 mm L6-062-33
 450 mm L6-062-45



De Bakey insert
working length Jaw insert
 220 mm L6-064-22
 330 mm L6-064-33
 450 mm L6-064-45



Babcock insert
working length Jaw insert
 220 mm L6-066-22
 330 mm L6-066-33
 450 mm L6-066-45



Paddle Babcock insert
working length Jaw insert
 220 mm L6-068-22
 330 mm L6-068-33
 450 mm L6-068-45



Baby Babcock insert
working length Jaw insert
 220 mm L6-070-22
 330 mm L6-070-33
 450 mm L6-070-45



Biopsy Spoon, double action

<u>Working length</u>	<u>Jaw insert</u>
220 mm	L6-080-22
330 mm	L6-080-33
450 mm	L6-080-45



Biopsy spoon with teeth, double action

<u>Working length</u>	<u>Jaw insert</u>
220 mm	L6-082-22
330 mm	L6-082-33
450 mm	L6-082-45



Biopsy Spoon, single action

<u>Working length</u>	<u>Jaw insert</u>
220 mm	L6-084-22
330 mm	L6-084-33
450 mm	L6-084-45



Biopsy Spoon with teeth, single action

<u>Working length</u>	<u>Jaw insert</u>
220 mm	L6-086-22
330 mm	L6-086-33
450 mm	L6-086-45



Blakesley biopsy insert

<u>Working length</u>	<u>Jaw insert</u>
220 mm	L6-088-22
330 mm	L6-088-33
450 mm	L6-088-45



Biopsy punch insert

<u>Working length</u>	<u>Jaw insert</u>
220 mm	L6-090-22
330 mm	L6-090-33
450 mm	L6-090-45



Multiple teeth insert

<u>Working length</u>	<u>Jaw insert</u>
220 mm	L6-092-22
330 mm	L6-092-33
450 mm	L6-092-45



Rat-Tooth inser

<u>Working length</u>	<u>Jaw insert</u>
220 mm	L6-094-22
330 mm	L6-094-33
450 mm	L6-094-45



Claw insert

<u>Working length</u>	<u>Jaw insert</u>
220 mm	L6-096-22
330 mm	L6-096-33
450 mm	L6-096-45



Tenaculum insert

<u>Working length</u>	<u>Jaw insert</u>
220 mm	L6-098-22
330 mm	L6-098-33
450 mm	L6-098-45



Micro scissors, straight

<u>Working length</u>	<u>Jaw insert</u>
220 mm	L6-200-22
330 mm	L6-200-33
450 mm	L6-200-45



Micro scissors, curved

<u>Working length</u>	<u>Jaw insert</u>
220 mm	L6-202-22
330 mm	L6-202-33
450 mm	L6-202-45



Peritoneal scissors, serrated

<u>Working length</u>	<u>Jaw insert</u>
220 mm	L6-204-22
330 mm	L6-204-33
450 mm	L6-204-45



Hook scissors

<u>Working length</u>	<u>Jaw insert</u>
220 mm	L6-206-22
330 mm	L6-206-33
450 mm	L6-206-45



Baby-Metzenbaum, curved

<u>Working length</u>	<u>Jaw insert</u>
220 mm	L6-208-22
330 mm	L6-208-33
450 mm	L6-208-45



Metzenbaum scissors, curved

<u>Working length</u>	<u>Jaw insert</u>
220 mm	L6-210-22
330 mm	L6-210-33
450 mm	L6-210-45



Endo scissors, curved

<u>Working length</u>	<u>Jaw insert</u>
220 mm	L6-214-22
330 mm	L6-214-33
450 mm	L6-214-45



Metzenbaum scissors, straight heavy blades pattern

<u>Working length</u>	<u>Jaw insert</u>
220 mm	L6-216-22
330 mm	L6-216-33
450 mm	L6-216-45



Metzenbaum scissors, curved heavy blades pattern

<u>Working length</u>	<u>Jaw insert</u>
220 mm	L6-218-22
330 mm	L6-218-33
450 mm	L6-218-45





10 mm Maryland insert for 5-10mm shaft 19.61/XX

<u>Working length</u>	<u>Jaw insert</u>
220 mm	L6-110-22
330 mm	L6-110-33
450 mm	L6-110-45



10 mm Alligator insert for 5-10mm shaft 19.61/XX

<u>Working length</u>	<u>Jaw insert</u>
220 mm	L6-132-22
330 mm	L6-132-33
450 mm	L6-132-45



90° Mixer insert, 10mm shaft

<u>Working length</u>	<u>Jaw insert</u>
220 mm	L6-150-22
330 mm	L6-150-33
450 mm	L6-150-45



Allis insert, 10mm shaft

<u>Working length</u>	<u>Jaw insert</u>
220 mm	L6-152-22
330 mm	L6-152-33
450 mm	L6-152-45



Allis, atraumatic insert, 10mm shaft

<u>Working length</u>	<u>Jaw insert</u>
220 mm	L6-154-22
330 mm	L6-154-33
450 mm	L6-154-45



Babcock grasping forceps, 10 mm shaft

<u>Working length</u>	<u>Jaw insert</u>
220 mm	L6-156-22
330 mm	L6-156-33
450 mm	L6-156-45



Paddle babcock insert, 10 mm shaft

<u>Working length</u>	<u>Jaw insert</u>
220 mm	L6-157-22
330 mm	L6-157-33
450 mm	L6-157-45



Spoon insert, single action, 10 mm shaft

<u>Working length</u>	<u>Jaw insert</u>
220 mm	L6-170-22
330 mm	L6-170-33
450 mm	L6-170-45



Claw insert, single action, 10 mm shaft

<u>Working length</u>	<u>Jaw insert</u>
220 mm	L6-172-22
330 mm	L6-172-33
450 mm	L6-172-45













Claw insert, double action, 10 mm shaft

<u>Working length</u>	<u>Jaw insert</u>
220 mm	L6-174-22
330 mm	L6-174-33
450 mm	L6-174-45

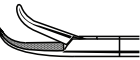

Tenaculum insert, 10 mm shaft





<u>Working length</u>	<u>Jaw insert</u>
220 mm	L6-176-22
330 mm	L6-176-33
450 mm	L6-176-45

	Metal Handle with Spring and Cleaning Port, not rotating, not detachable  L7-B	Ratchet with Cleaning Port, not rotating, not detachable  L7-D	Axial Handle with ratchet and Cleaning Port, not rotating, not detachable  L7-F
	Tungsten Carbide, 3 mm 220 mm L7-340-22B 330 mm L7-340-33B 450 mm L7-340-45B	Tungsten Carbide, 3 mm 220 mm L7-340-22D 330 mm L7-340-33D 450 mm L7-340-45D	Tungsten Carbide, 3 mm 220 mm L7-340-22F 330 mm L7-340-33F 450 mm L7-340-45F
	Serrated Jaw, 3 mm 220 mm L7-342-22B 330 mm L7-342-33B 450 mm L7-342-45B	Serrated Jaw, 3 mm 220 mm L7-342-22D 330 mm L7-342-33D 450 mm L7-342-45D	Serrated Jaw, 3 mm 220 mm L7-342-22F 330 mm L7-342-33F 450 mm L7-342-45F
	Tungsten Carbide, 5 mm 220 mm L7-350-22B 330 mm L7-350-33B 450 mm L7-350-45B	Tungsten Carbide, 5 mm 220 mm L7-350-22D 330 mm L7-350-33D 450 mm L7-350-45D	Tungsten Carbide, 5 mm 220 mm L7-350-22F 330 mm L7-350-33F 450 mm L7-350-45F
	Serrated Jaw, 5 mm 220 mm L7-352-22B 330 mm L7-352-33B 450 mm L7-352-45B	Serrated Jaw, 5 mm 220 mm L7-352-22D 330 mm L7-352-33D 450 mm L7-352-45D	Serrated Jaw, 5 mm 220 mm L7-352-22F 330 mm L7-352-33F 450 mm L7-352-45F
	"Flamingo", 5 mm 220 mm L7-360-22B 330 mm L7-360-33B 450 mm L7-360-45B	"Flamingo", 5 mm 220 mm L7-360-22D 330 mm L7-360-33D 450 mm L7-360-45D	"Flamingo", 5 mm 220 mm L7-360-22F 330 mm L7-360-33F 450 mm L7-360-45F
	"Parrot", 5 mm 220 mm L7-362-22B 330 mm L7-362-33B 450 mm L7-362-45B	"Parrot", 5 mm 220 mm L7-362-22D 330 mm L7-362-33D 450 mm L7-362-45D	"Parrot", 5 mm 220 mm L7-362-22F 330 mm L7-362-33F 450 mm L7-362-45F
	Tungsten Carbide, Curved left, 5 mm 220 mm L7-364-22B 330 mm L7-364-33B 450 mm L7-364-45B	Tungsten Carbide, Curved left, 5 mm 220 mm L7-364-22D 330 mm L7-364-33D 450 mm L7-364-45D	Tungsten Carbide, Curved left, 5 mm 220 mm L7-364-22F 330 mm L7-364-33F 450 mm L7-364-45F
	Tungsten Carbide, Curved curved, 5 mm 220 mm L7-368-22B 330 mm L7-368-33B 450 mm L7-368-45B	Tungsten Carbide, Curved curved, 5 mm 220 mm L7-368-22D 330 mm L7-368-33D 450 mm L7-368-45D	Tungsten Carbide, Curved curved, 5 mm 220 mm L7-368-22F 330 mm L7-368-33F 450 mm L7-368-45F

Axial Handle with ratchet and Cleaning Port,
not rotating, not detachable



L7-G

	<u>Art. N°</u>	<u>∅</u>	<u>Length</u>	<u>Typ</u>
	L30-5-330 S L35-5-330 S L50-5-330 S L30-5-450 S L35-5-450 S L50-5-450 S	3,0 3,5 5,0 3,0 3,5 5,0	330 mm 330 mm 330 mm 450 mm 450 mm 450 mm	Gerade
	L30-5-330 R L35-5-330 R L50-5-330 R L30-5-450 R L35-5-450 R L50-5-450 R	3,0 3,5 5,0 3,0 3,5 5,0	330 mm 330 mm 330 mm 450 mm 450 mm 450 mm	Rechts
	L30-5-330 L L35-5-330 L L50-5-330 L L30-5-450 L L35-5-450 L L50-5-450 L	3,0 3,5 5,0 3,0 3,5 5,0	330 mm 330 mm 330 mm 450 mm 450 mm 450 mm	Links
	L50-5-330 C L50-5-450 C	5,0 5,0	330 mm 450 mm	Konkav Konvex
	L50-5-330 F L50-5-450 F	5,0 5,0	330 mm 450 mm	Flamingo

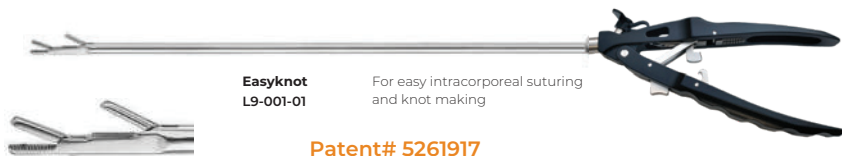

Step 1

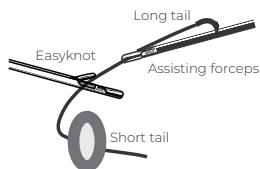

Take the stitch with a standard needle holder leaving a 1"-2" short tail on the needle entry side. Grasp the needle end of the suture with an assisting forceps about 3"-5" from the operative site to fix the suture. Trap the suture under the upper jaw of the Easyknot device about 1.5" from the point of suture fixation.

Step 2

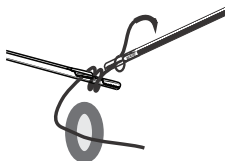

Use the assisting forceps to wrap the suture around the Easyknot device twice, distal to the upper jaw (preferably going first under device than over it)

Step 3

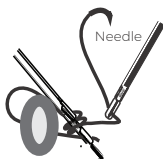

Bring both instruments closer to the short tail and hold the tail with the lower Jaw of the Easyknot device. Open the upper jaw to release trapped suture and pull the device (Holding the suture tail) and assisting forceps (holding the needle suture end) in opposite directions (relative to initial positions) to establish a flat half hitch. Cinch and tighten as needed.

Step 4

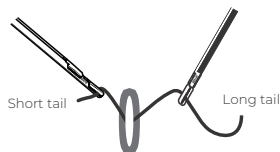

Repeat the procedure to form additional half hitches making sure to reverse the direction of pulling on the suture ends to establish a square knot. For instance, if the short end starts on the right side of the incision, it should end at the left side after the first half hitch and again on the right side after the second half hitch

Developed in cooperation with Drs Carlos Rotman and Harrit Hasson, Chicago/USA

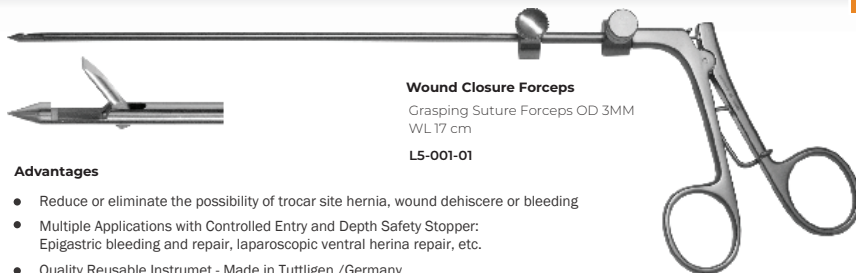

Advantages

- Reduce or eliminate the possibility of trocar site hernia, wound dehiscere or bleeding
- Multiple Applications with Controlled Entry and Depth Safety Stopper: Epigastric bleeding and repair, laparoscopic ventral herina repair, etc.
- Quality Reusable Instrument - Made in Tuttlingen /Germany
- Easy to use, specially on obese patients

■ PORTABLE LED LIGHT 10W



FEATURES

Compact and portable, the built-in lithium battery allows the Mini Handheld Cold Light Source to work more than 2 hours after being recharged.

We design and manufacture it for use either with a rigid or flexible endoscope.

A particularly well conceived safety feature is the automatic switchover from main light source to the spare light source in case of light source failure.

Therefore the light source is always ready for emergency use and contributes to patient safety.



10W LED

E-L10P

Includes:

- LED Device
- 2 rechargeable batteries
- Charger
- Small travel case optional



■ HEADLIGHT SPECIAL

10W ULTRA-BRIGHT & LITE Weight Headlight
Focusable



*also with zoom option

10W ultra bright -lite **E-HL10**
focusable **E-HL10F**

10W ULTRA-BRIGHT Weight Headlight



10W- weight **E-HL10U**

LED 5W HEADLIGHT Wireless



Led5- wireless **E-HL5L**

Characteristics

Applications:
Surgical, for dentistry,
veterinary

Lighting type:
LED

Other features:
With rechargeable battery, for binocular
loupe, with portable light source

Headlights include:



- ▷ Portable travel case
- ▷ 1 Charger
- ▷ 2 rechargeable lithium-ion batteries



MEDICAL
Technology Germany

 RG Medical USA, Inc. |  630 Pleasant Grove Rd, Mount Juliet, TN 37122

 +1 615 692 1375

www.rgmed.com